

238T PANEL

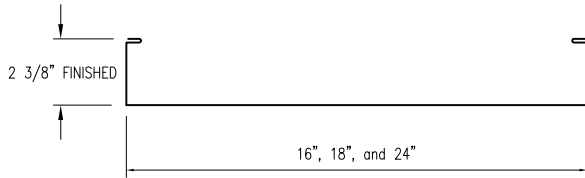

238T PANEL PROFILE
Standard Width- 16"-18" and 24"

Applications

Symmetrical structural roof/wall panel used on slopes down to 1/4:12. Continuous length up to 300ft. Tapered panels up to 60ft. Convex and concave curving available.

Substrates

Plywood-Nailers-Subgirts-Purlins-Metal Deck

Standard Materials

Alum-Zinc coated steel
.040 Aluminum

Standard Gauge

24 ga. 22 ga.

Finishes

Acrylic Coated Galvalume and Fluoropolymer (Kynar 500)

Texture

Smooth, Striations, Stiffener Ribs

Manufacturing

Factory, Jobsite

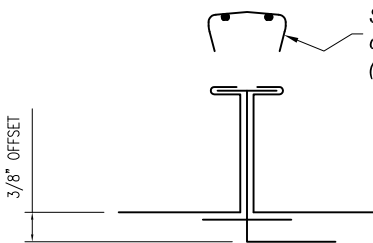

SEAM ENGAGEMENT

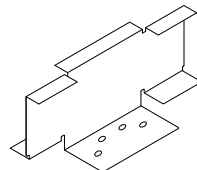

STANDARD CLIP
16 GAUGE

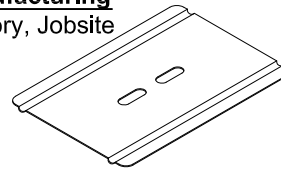

BEARING PLATE
24 GAUGE, 50 KSI STEEL.

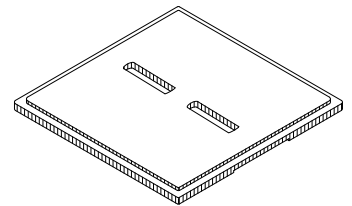

STACKABLE LEVELING SHIM
6" x 6" x 1/4" THICK

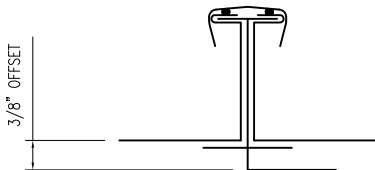

BEFORE SEAMING

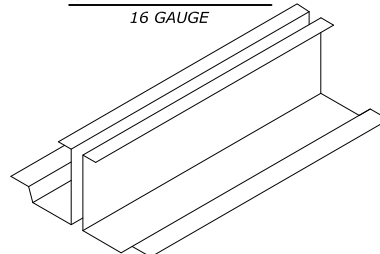

MULTISPAN CLIP
2-PIECE

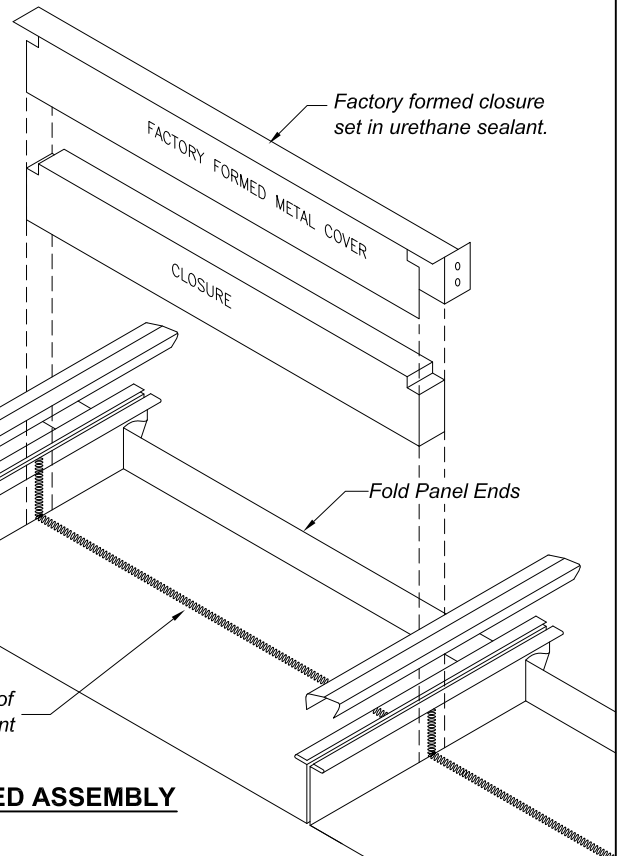

EXPLODED ASSEMBLY

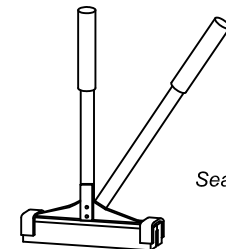

HAND SEAMER

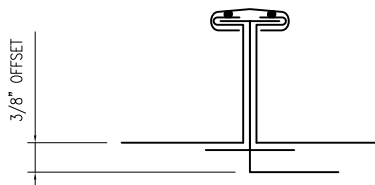

AFTER SEAMING

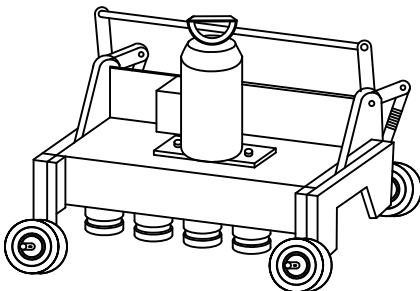

MECHANICAL SEAMER