

Permaseam Standing Seam Panel

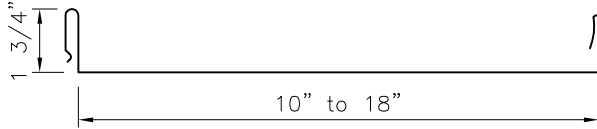

SMOOTH PROFILE

Optimum Widths 10", 12", 16" and 18"

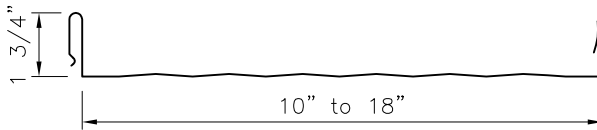

STRIATED PROFILE

Optimum Widths 10", 12", 16" and 18"

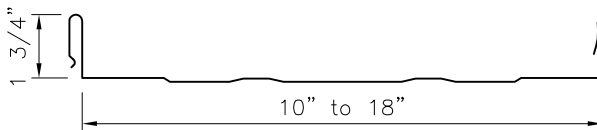

STIFFENER RIBS PROFILE

Optimum Widths 10", 12", 16" and 18"

Applications

Structural panel used on roof slopes of 2" per foot or greater. Continuous lengths up to 100 ft.

Substrates

Plywood, Metal Deck (Recommended for Solid Deck)

Standard Material

Alum-Zinc coated steel

Standard Gauge

24ga.

Finishes

Acrylic Coated Galvalume and Fluoropolymer (Kynar 500® PVDF resin-based)

Optional Gauge

22ga.

Texture

Smooth, Striated, Stiffener Ribs

Manufacturing

Factory or Jobsite Roll-formed

Testing / Agency Approvals

Uplift: UL 580, UL 1897

Air & Water Infiltration: ASTM E-1680, ASTM E-1646

Impact Resistance: UL Class 4; Fire Rating: UL Class A

Texas Windstorm; Florida Building Code

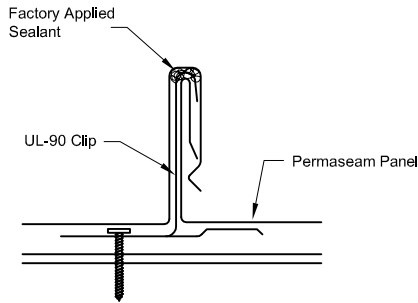

SEAM ENGAGEMENT

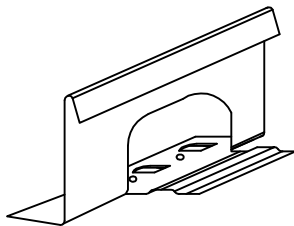

UL-90 CLIP

(2 Fasteners) 16 GA.

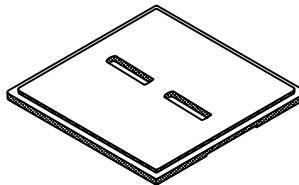

STACKABLE LEVELING SHIM

6" x 6" x 1/4" Thick

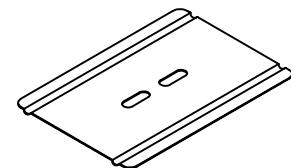

BEARING PLATE

24 GA. 50 KSI Steel.