

- ① JSM 200, MECHANICALLY FIELD SEAMED ROOF PANEL
- ② CONCEALED CLIP
- ③ EXTENDED EAVE TRIM
- ④ CONTINUOUS CLEAT

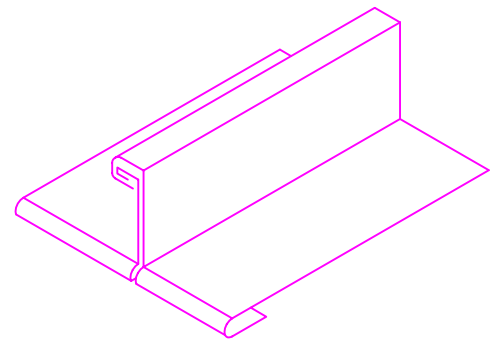

PANEL END AFTER FOLDING HEM

ARCHITECTURAL BUILDING COMPONENTS
 11625 N. HOUSTON ROSSLYN RD.
 HOUSTON, TX. 77086
 (281) 931-3986 OR (800) 423-1105
 FAX: (281) 931-3989
 www.archmetalroof.com

DETAIL:
 STANDARD EAVE

PANEL TYPE:
 JSM ROOF SYSTEM

DATE:
 10-10-02

DETAIL #:
 J2-4